

ApneaLink Air

Home Sleep Testing

PATIENT INSTRUCTIONS

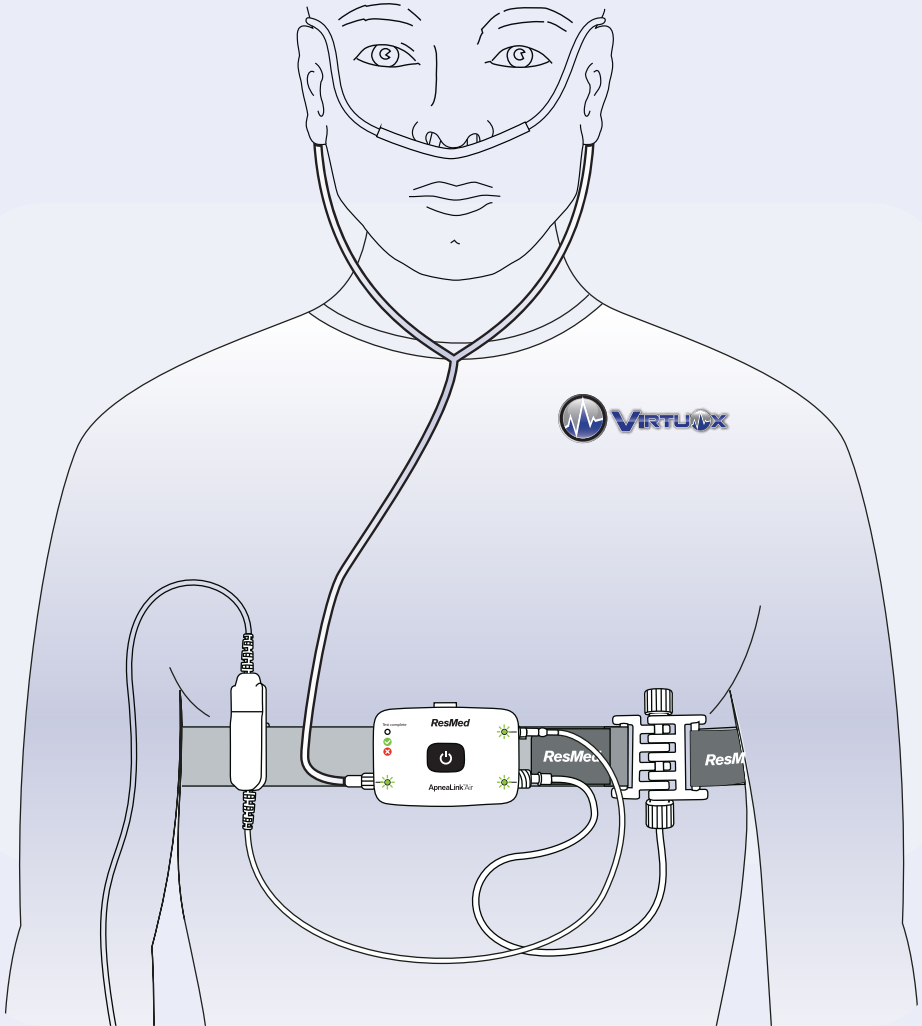

VirtuOx Patient Support
(877) 897-0063
www.virtuox.net



Home Sleep Test Equipment

Please take a moment to familiarize yourself with what is included in the kit:

1. ApneaLink Air home sleep test device (with sensors attached and new batteries pre-installed)

2. Nasal cannula

3. Finger sensor

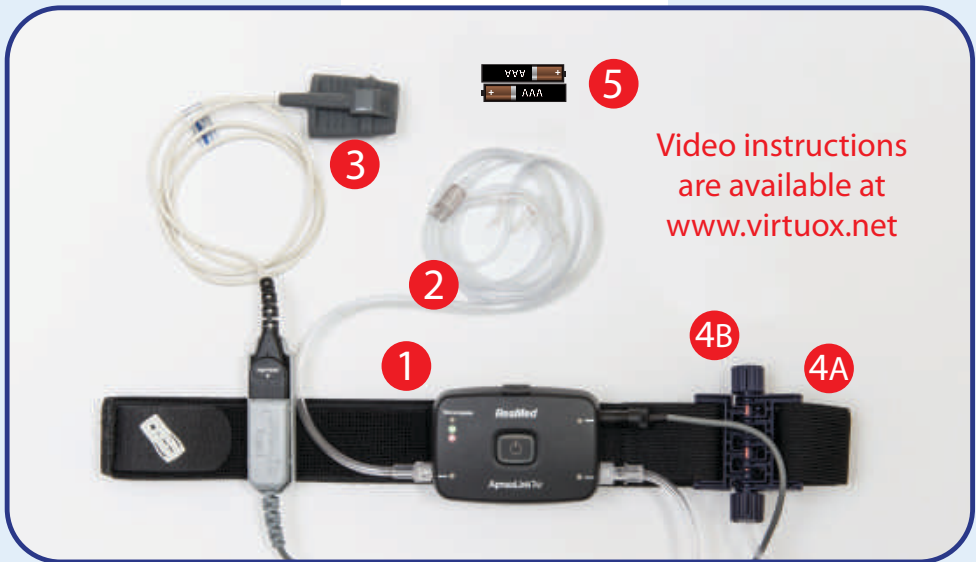

4A. Black elastic chest belt

4B. Effort sensor (measures your chest movement)

5. Extra AAA batteries



Reminder:

Do not turn the device on until you are ready to go to bed and test!
You should continue to take any medications, as directed by your prescriber.
Please test and return the device promptly!

Home Sleep Test Instructions

Please read these instructions carefully and follow the directions

Step 1: Apply the chest belt

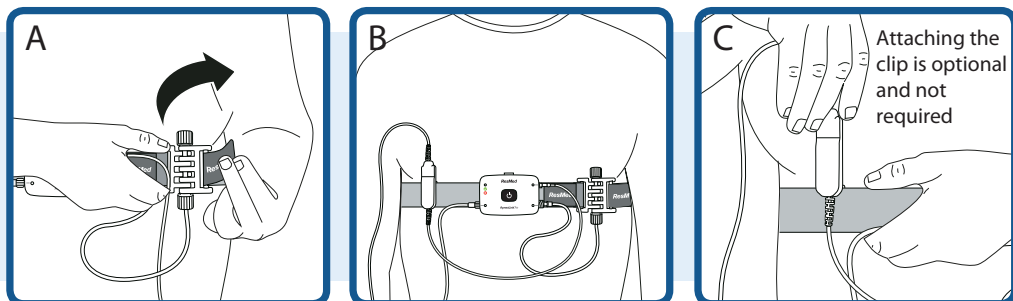

- With the device in front, wrap the chest belt around your body and over your sleepwear, as shown. Secure the chest belt with the Velcro tabs. The belt should be snug, but not uncomfortable.

- **!** The manufacturer recommends that the device be placed at center of your chest, over or under your breasts. If, however, you cannot sleep on your back, you may rotate the belt so the device is at your side.

Step 2: Apply the finger sensor

Important! Please remove any nail polish or artificial nails from the finger on which the sensor will be applied.

- Slide your finger into the finger sensor. The wire should run along the top of your hand, as shown.
- Your finger should not stick out of the end of the sensor.
- You may change fingers, as needed, for comfort.

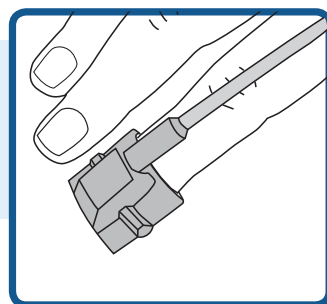

Note: You may use Band-Aids or hypoallergenic tape to secure the wire to your finger.

Step 3: Apply the nasal cannula

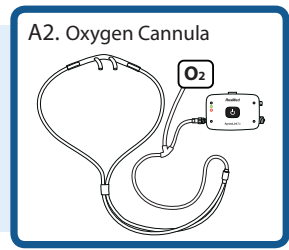
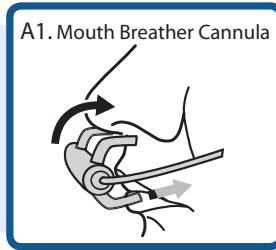
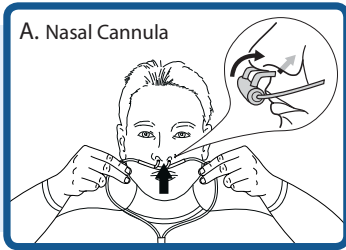

- A. Nasal Cannula - With prongs facing downward and towards your face, insert the nasal cannula with one prong in each nostril, as shown.
- A1. Mouth Breather Cannula (optional) - There will be an additional curved prong towards your mouth.
- A2. Oxygen Cannula (optional) - You will connect one end to your oxygen source.

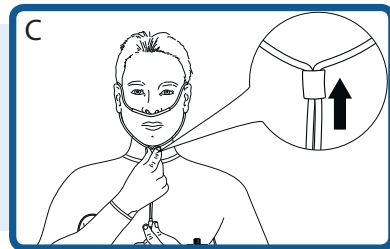
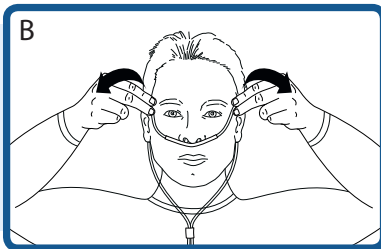

- B. Wrap the cannula behind your ears.
- C. Adjust the slider so that the loop fits securely under your chin.

Note: You may use Band-Aids or hypoallergenic tape to keep the nasal cannula in place.

! If the nasal cannula is not already attached, please attach by twisting the connector onto the device.

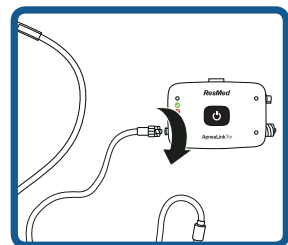

Step 4: Turn on the device

- When you are ready for bed, press and hold the power button until the lights start to appear. Note that this process may take up to 30 seconds.

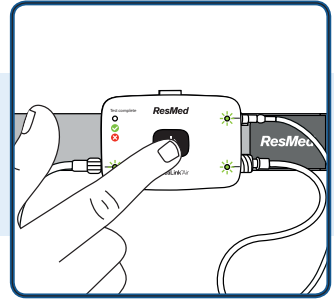

- ! **If any of the lights remain red for an extended time, please check the appropriate sensor for a secure connection to the device and appropriate placement on your body. It is normal for the lights to occasionally blink from green to red. Note that the light INSIDE the finger sensor where your finger is placed, should remain RED.**

Step 5: Go to sleep

- Now you are ready to go to sleep. It is normal for the lights on the device to dim after several minutes.

Note: We would like a minimum of four hours of sleep for each night of testing.

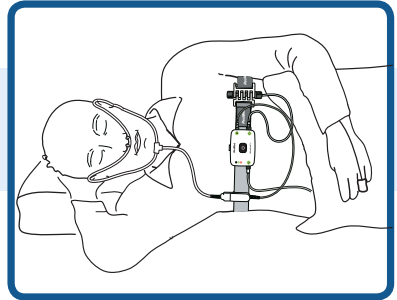

If you need to use the restroom during the night, simply remove the finger sensor. DO NOT disconnect the finger sensor from the device or turn the device off. Put the finger sensor back on when you return to bed and continue testing.

Step 6: Turn off the device

- When you wake up the next morning and are finished testing for the night, press and hold the power button until the device powers down.

- ! **If the “test complete” indicator light comes on, please disregard. This is for internal purposes only.**

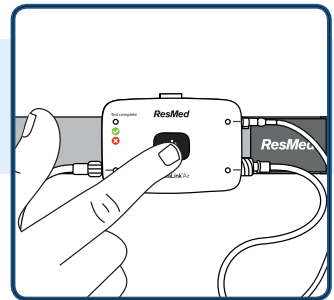

Important! Unless instructed otherwise, you will be testing for two nights.

Step 7: Second night of testing

- Remove the battery covering from the back of the device.
- Remove the used batteries and replace them with the new batteries that were provided.
- Repeat Steps 1-6 for your second night of testing.

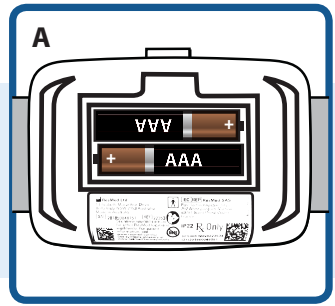

- ! **Place the batteries in the correct direction.**
*See figure A.

Step 8: Complete all paperwork

- Complete paperwork and return it with your device.



Step 9: Package the device and return to VirtuOx

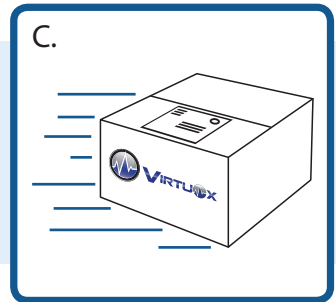
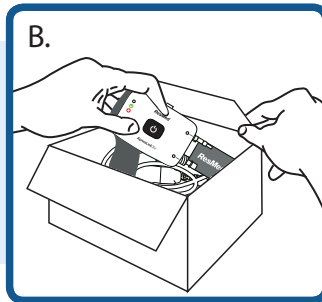
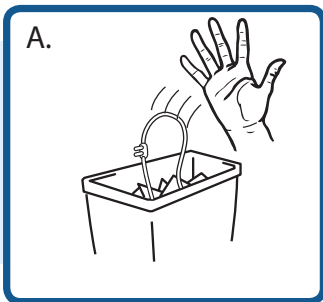

- A. You may unscrew the nasal cannula from the device and discard it. **DO NOT** disconnect any other attachments.
- B. Replace the device, including all other attachments, and the completed paperwork into the provided return package on the next business day.
- C. Use the appropriate shipping carrier on the provided label to return to VirtuOx.

Important! Please send the device back to VirtuOx promptly! This will prevent any delays in getting the test results to your ordering prescriber.

What's Next? Your prescriber should receive the results within two weeks from the day you mail the package back to VirtuOx. Please contact your prescriber to discuss the results and treatment options, if needed.

Frequently Asked Questions

Q Are there video instructions?

A Yes, please visit www.virtuox.net and look under the patient section.

Q I woke up during the night and the device was off. What do I need to do?

A Please turn the device back on and continue testing.

Q The device will not power on.

A If the device will not power on after pressing and holding the power button for 30 seconds, please replace the batteries.

Q Should I power off the device if I wake up during the night?

A No, you should not power off the device unless you do not plan on going back to sleep.

Q What should I do if the green light for a sensor does not come on?

A Check the appropriate sensor for a secure connection to the device and the appropriate placement on your body. If the green light still does not come on, please contact VirtuOx Patient Support at (877) 897-0063.

Q What can I do if the finger sensor or nasal cannula will not stay in place?

A You may secure it by using Band-Aids or hypoallergenic tape.

Q What if the cannula is not connected to the device?

A You can connect the cannula by twisting it onto the device.

Q What if the finger sensor becomes uncomfortable during the night?

A You may switch to another finger.

Q Do I need to contact you before I begin testing?

A No, you do not need to contact us prior to testing.

Q When will I get my results?

A Please contact your ordering prescriber for your results.

Q How many nights do I need to test?

A You should test for two nights, unless you were instructed otherwise.



If you have any Home Sleep Test questions please call VirtuOx Patient Support at (877) 897-0063. VirtuOx Patient Support is available to help you 24 hours a day, 7 days a week!



www.virtuox.net



ApneaLink 062020